



Common Criteria  
Certified EAL3



*Member*

## What's New at Altair Engineering, Inc.

September 2011

Devin Jensen

We measure our success in terms of  
our customers' business performance.

innovation intelligence™



# Altair Knows HPC Apps

Altair is the only company that...

makes HPC Tools



makes HPC Apps,



and uses HPC Apps!

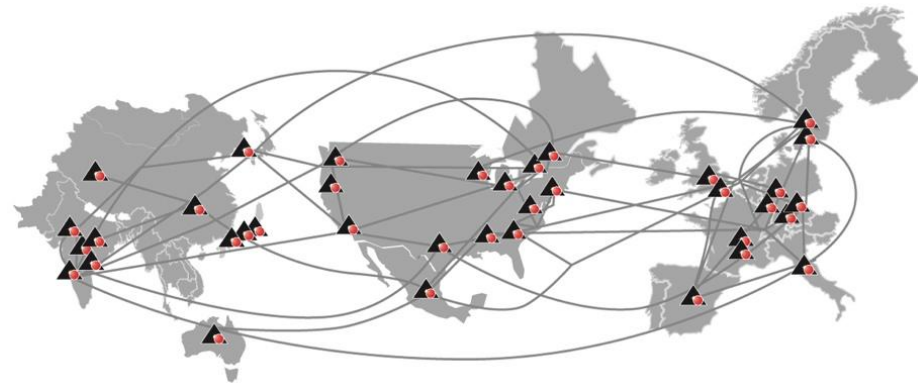

**600 Altair engineers worldwide  
use HPC every day for  
real-world modeling  
& simulation**

# Altair Overview

## Founded ...

In 1985 as a computer-aided product design company

## Today ...

A global software and technology company focused on advanced computing, optimizing simulation, analytics, & product development

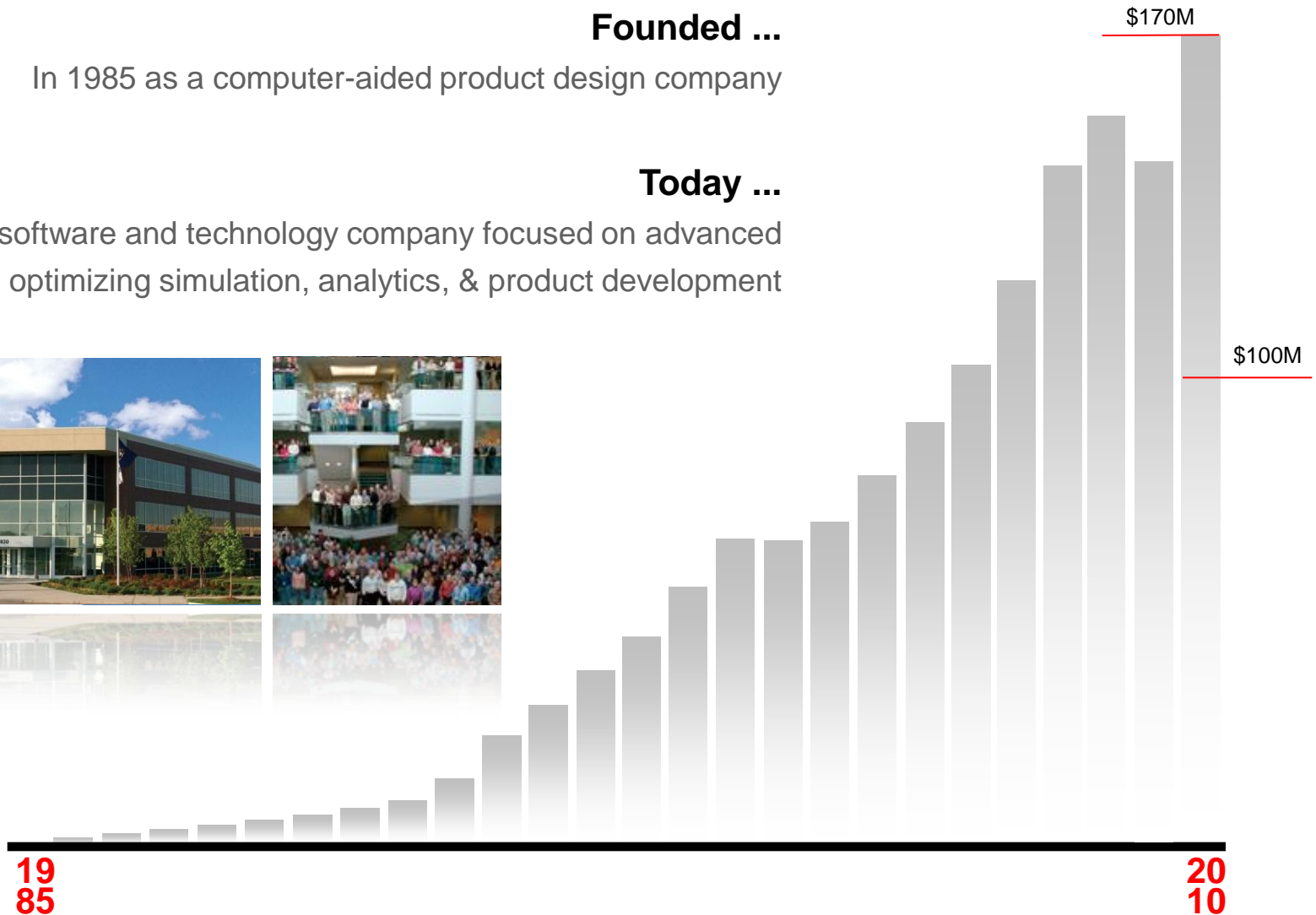

19  
85

20  
10

...got the knack?



# Thank You

---

Portals to Increase Productivity

Fault Avoidance to Reduce Risk

Scheduling to Maximize Value

Analytics to Optimize ROI

Open Architecture for Agility



[www.pbsworks.com](http://www.pbsworks.com)

# Global Offices

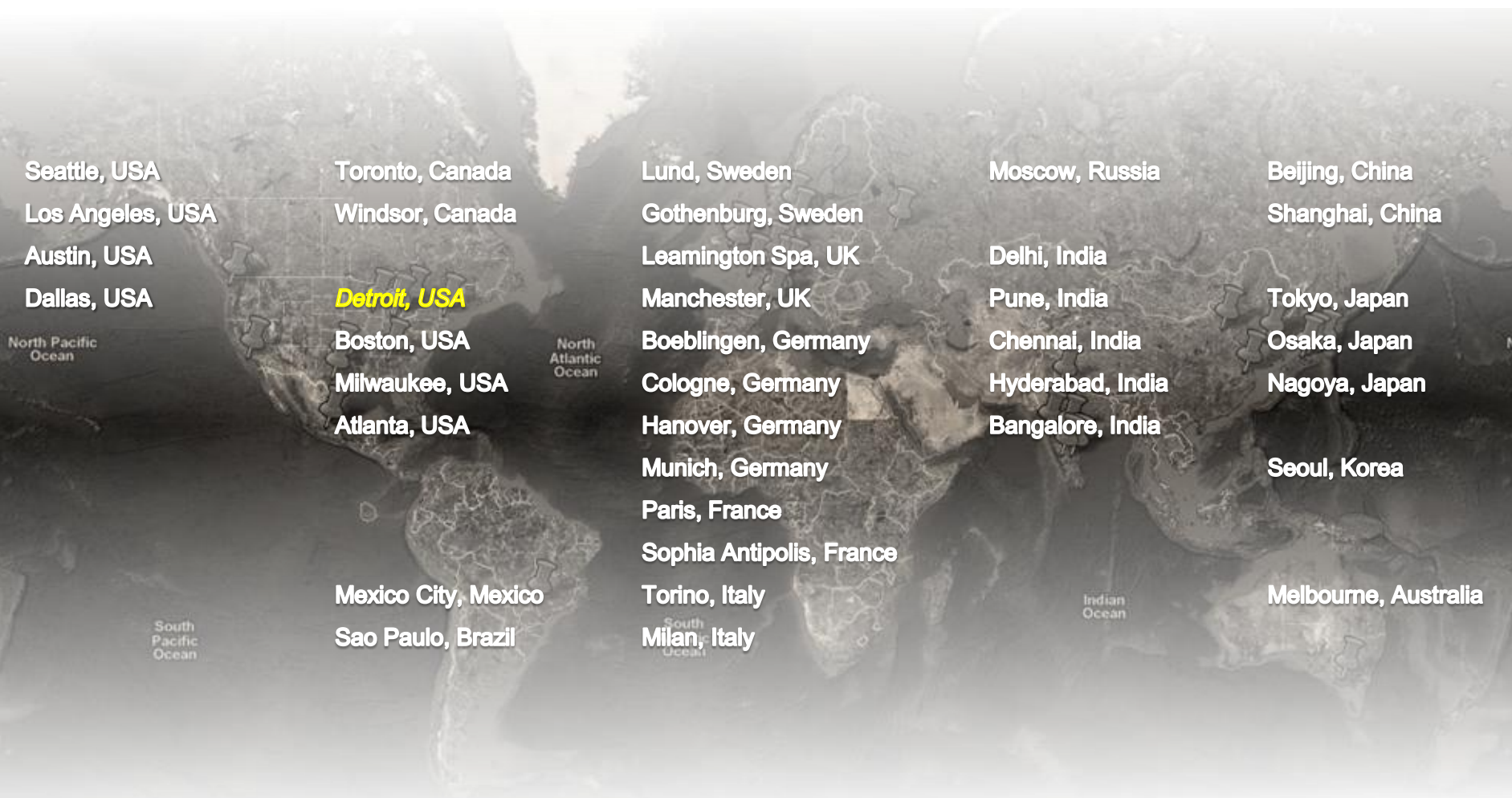

Seattle, USA

Los Angeles, USA

Austin, USA

Dallas, USA

Toronto, Canada

Windsor, Canada

**Detroit, USA**

Boston, USA

Milwaukee, USA

Atlanta, USA

Lund, Sweden

Gothenburg, Sweden

Leamington Spa, UK

Manchester, UK

Boeblingen, Germany

Cologne, Germany

Hanover, Germany

Munich, Germany

Paris, France

Sophia Antipolis, France

Torino, Italy

Milan, Italy

Moscow, Russia

Delhi, India

Pune, India

Chennai, India

Hyderabad, India

Bangalore, India

Beijing, China

Shanghai, China

Tokyo, Japan

Osaka, Japan

Nagoya, Japan

Seoul, Korea

Melbourne, Australia

# Altair Brands and Companies



## Solid State Lighting for a Greener, more Environmentally Sustainable Future™

- Spun out of Altair in April 2007
- More than 30 patents pending, including blockbuster patent for fluorescent replacement
- White light Solid State Lighting products
- Business Drivers: Energy Efficiency, Environmentally friendly, Superior Performance

### Partnerships and Early Adopters:



# What is Simulation?



[Click to Play](#)

# Simulation in Automotive

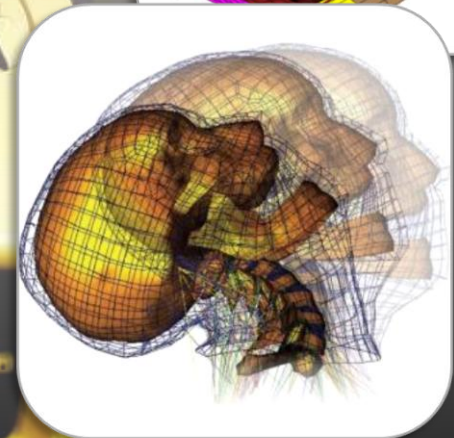
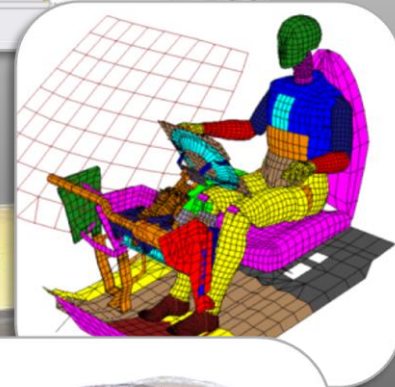
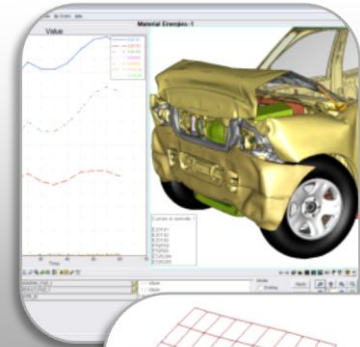

# Simulation in Aerospace

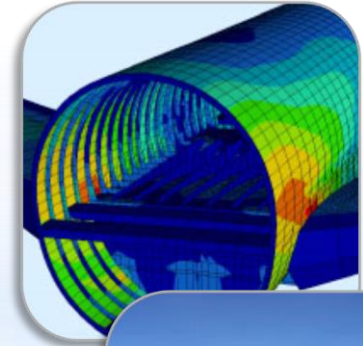

# Simulation in Sporting Goods

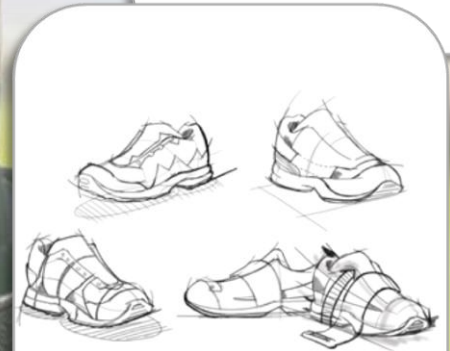
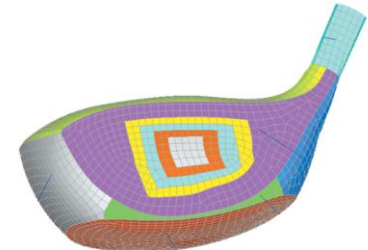
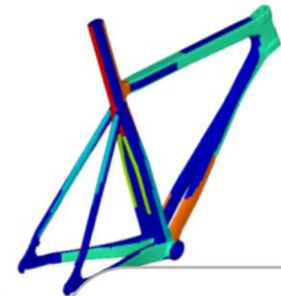

# Simulation in Consumer Goods

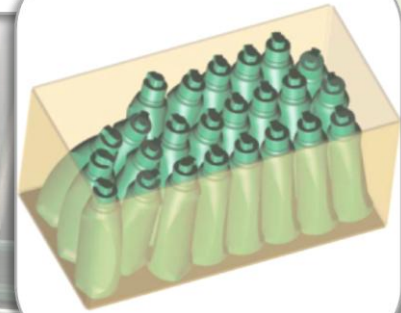
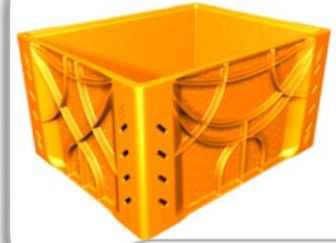

# Simulation in Health Industry

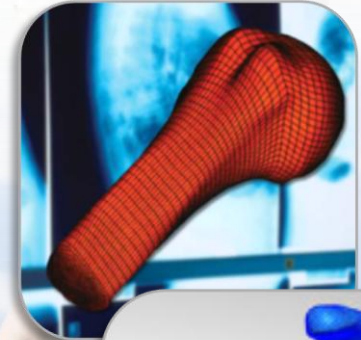

# Simulation in Heavy, Rail and Marine Industries

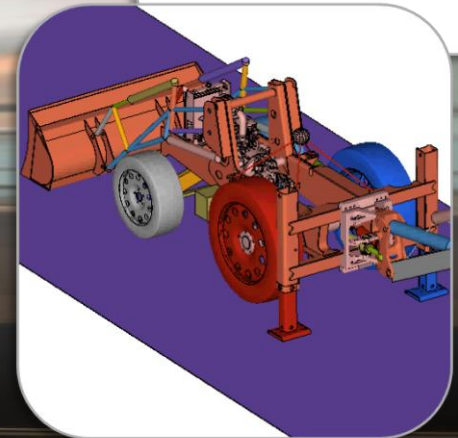
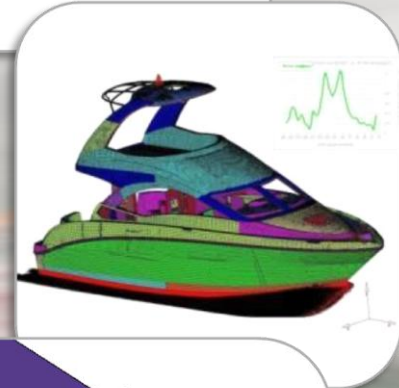

# Optimization: Simulation Leading the Design

---



***optimize***

[to make something more efficient]

+

***-ation***

[the result of an action or process]

# Getting the Best Design in the Shortest Time

## Optimization Examples



# Design & Simulation...

---

...blurring the boundaries



# Innovative Design Through Optimization

---

## Topology Optimization Examples

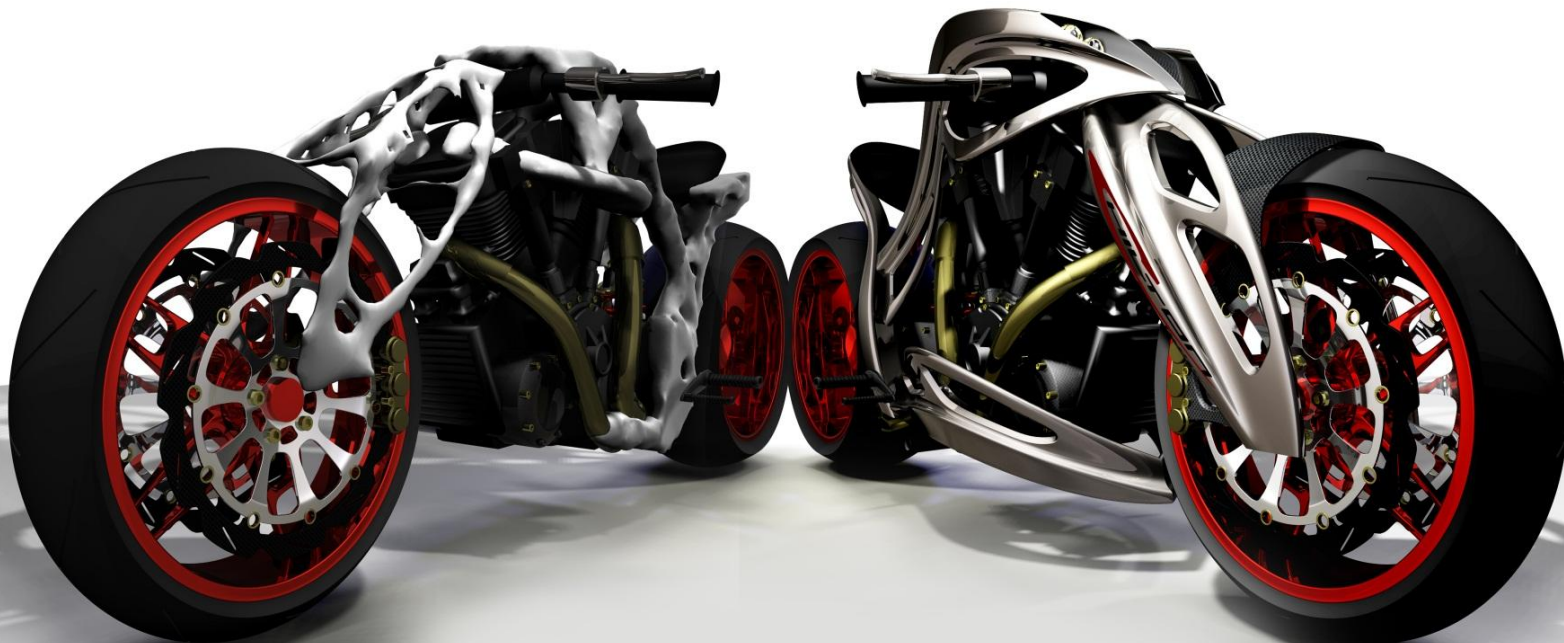

[Click to Play](#)

# Simulation Driven Innovation

---

**Extend human creativity**

**Non-intuitive solutions**

**Broader exploration space**

**Greater insight**

**The “right” answer.....faster**



# Careers in Engineering/Design @ Altair

---

At Altair, People are its greatest resource.

**Engineering Analyst**      **Software Application Engineer**  
**Software Development**  
**Mechanical Engineer**      *Computer Systems Administrator*  
**Designer**      *Structural Dynamic Analyst*  
**Lead Engineer**      **Sales and Marketing**  
*CAD Engineer*      **Quality Assurance Engineer**  
*Project Manager*



# Simulation @ Altair



**Click to Play**

# Thank You !

